

For your Complete
Industrial Solution

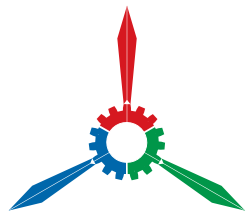

تنسور للتجارة ذ.م.م
Tensor Trading W.L.L

COMMERCIAL REG. NO. 138332, TELEPHONE: +974 40094609, FAX NUMBER: +974 40054801 E-MAIL: sales@tensor.qa
OFFICE NO 2, 2F BLOCK 55 SAYER BUILDING, BARWA COMMERCIAL AVE. ABU HAMOUR, DOHA, QATAR



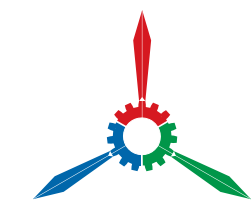
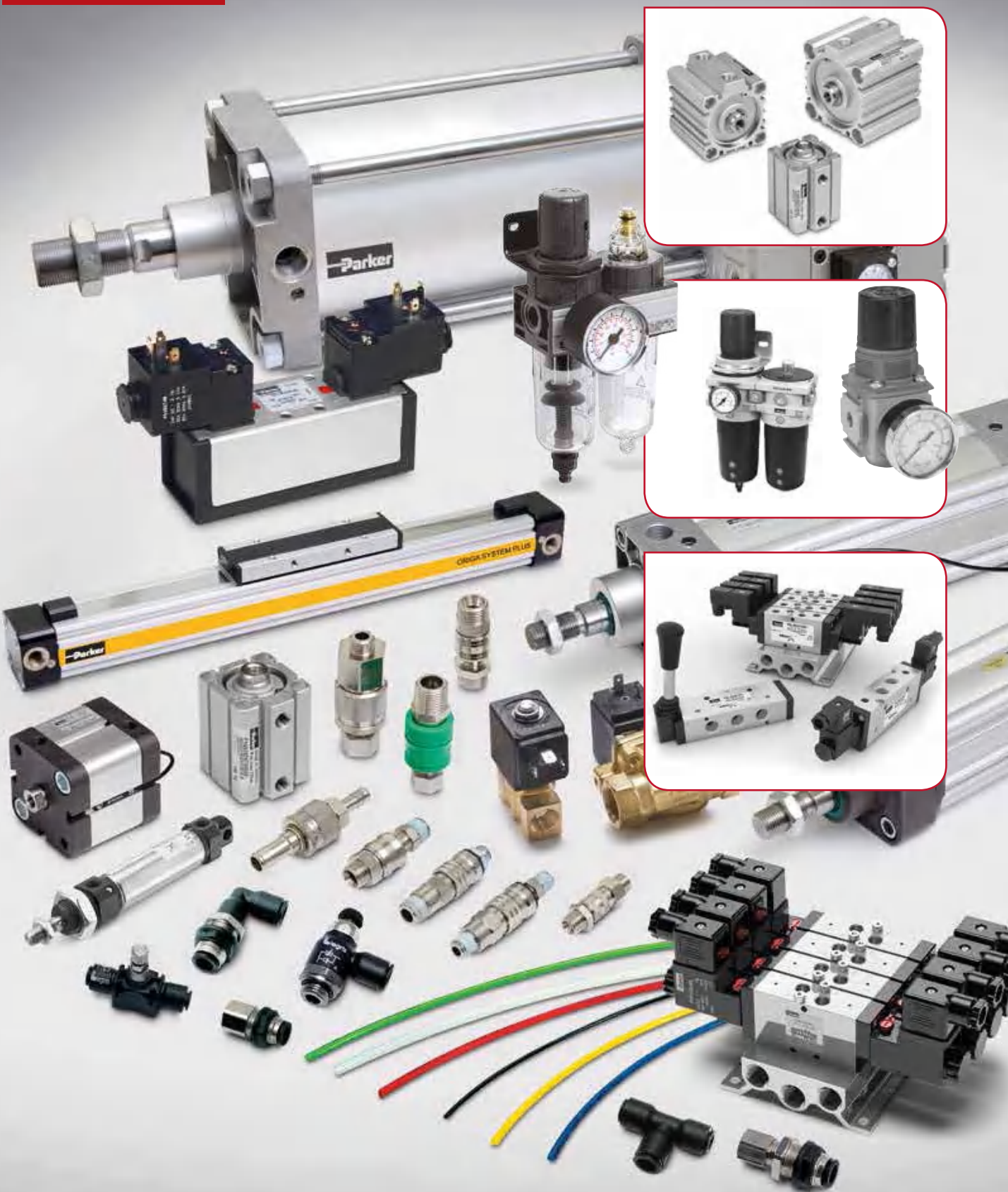



Push-in fittings and Connecters
Barbed fittings
Threaded fittings
Click fitting and accessories



Electrically and pneumatically actuated directional control valves and accessories
Pressure and Flow control valves etc



Service unit combinations, Filter regulator/lubricator
On-off valves and soft-start valves
Air distributor etc



Standard Cylinder
Round Cylinder
SS Cylinder etc
Cylinder attachments
Rod clevis, and accessories



All accessories
Standard O.D. tubing
Standard I.D. tubing
Spiral tubing
other Fittings and accessories



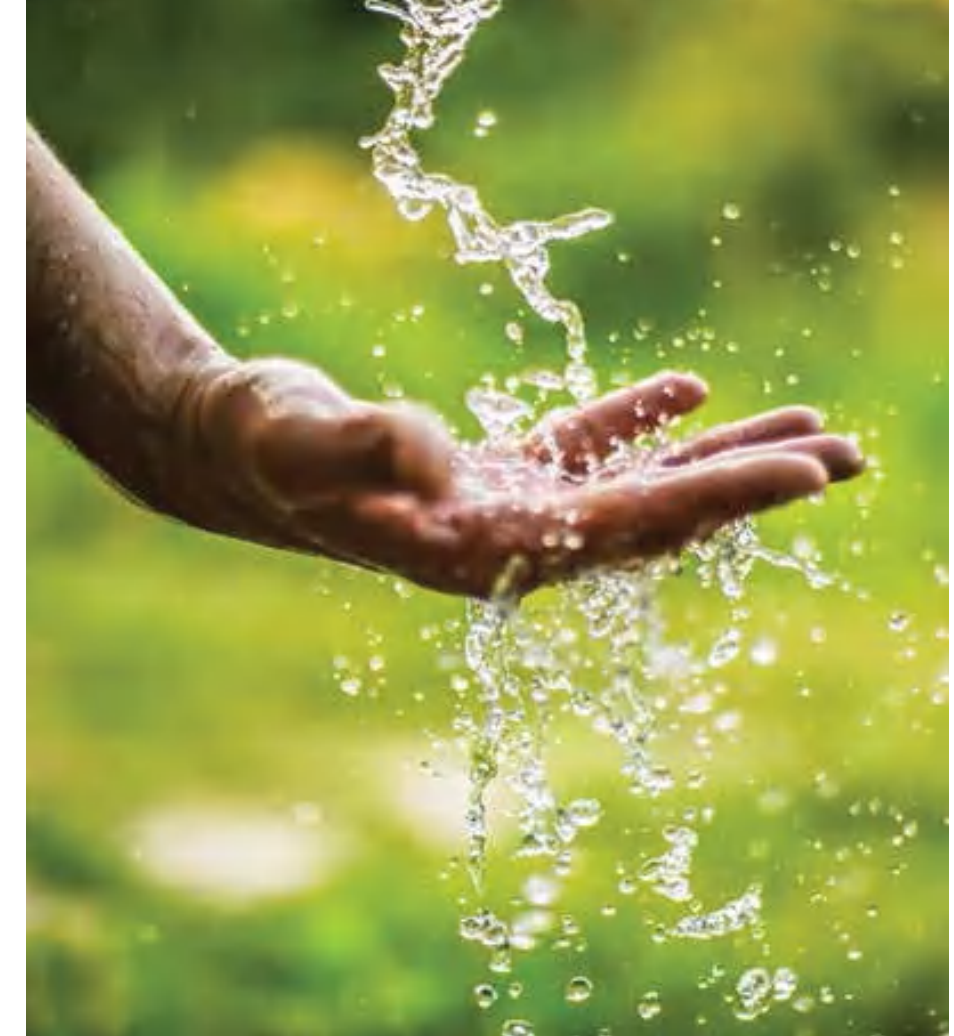
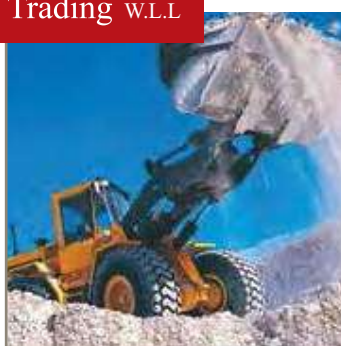

Hydraulic Hoses, Fittings and Equipment





Industrial Hydraulic Valves
Directional Control, Pressure Control, Sandwich,
Subplates & Manifolds, Accessories



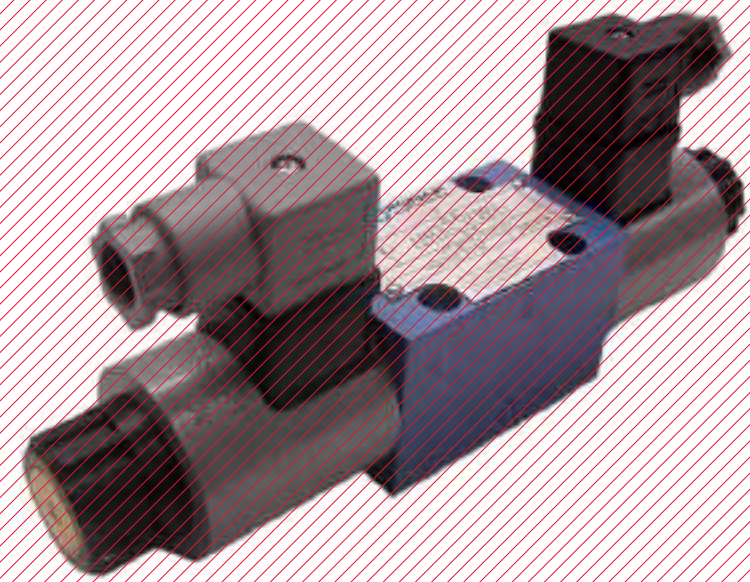
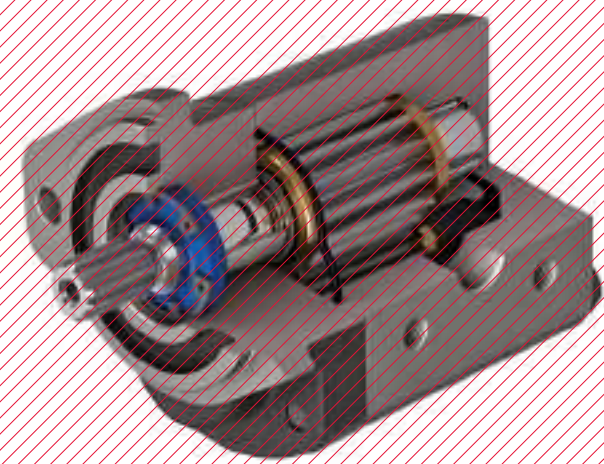
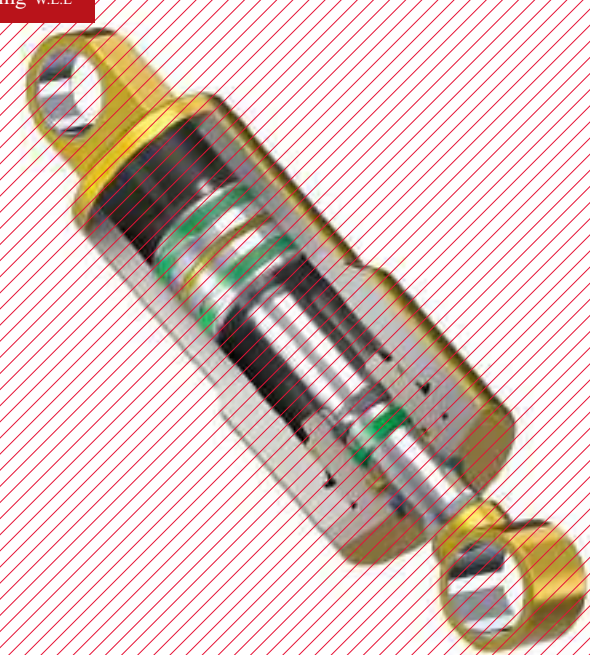

Standard Cylinder
Round Cylinder
SS Cylinder etc
Cylinder attachments
Rod clevis, rod eye
and accessories

Electrically and
pneumatically actuated
directional control
valves and accessories
Pressure and Flow
control valves etc

Service unit
combinations, Filter
regulator/lubricator
On-off valves and
soft-start valves
Air distributor etc

Standard Cylinder
Round Cylinder
SS Cylinder etc
Cylinder attachments
Rod clevis, rod eye
and accessories







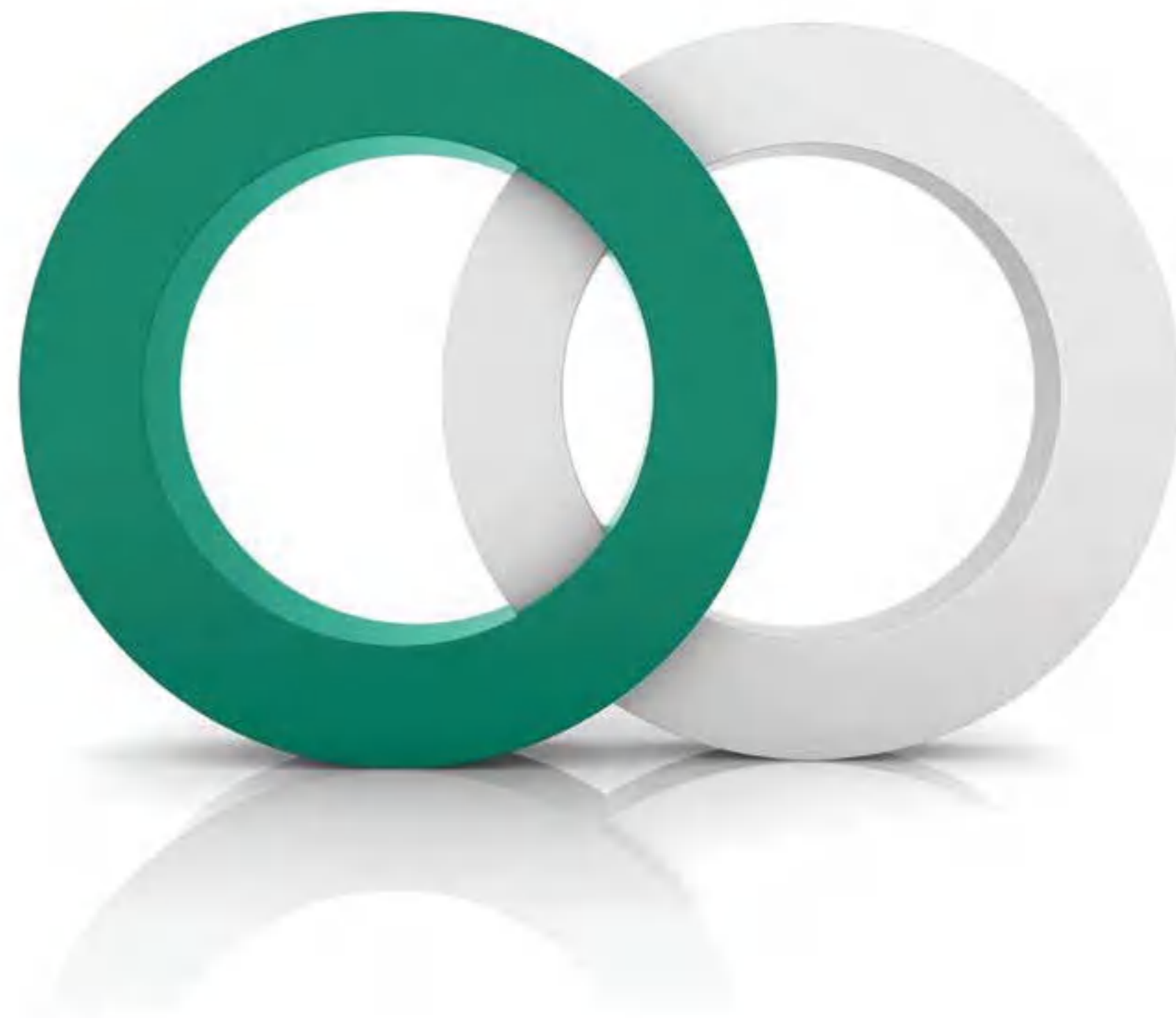











All accessories











Seals































Wipers

Profile	Type
	WR0 1
	WR01A
	WR0 2
	WR02A
	WR02B
	WR02C
	WR02D
	WR0 3
	WR0 4
	WR0 7
	WR0 8
	WR11
	WR12
	WR13
	WR13_E2
	WR14
	WR15
	WR17
	WR18





























Customized seals

Profile	Profile
	
	
	
	



















Rod seals

Profile	Type
	RS01
	RS01A
	RS01B
	RS01C
	RS02
	RS02A
	RS02B
	RS02C
	RS03
	RS04
	RS05
	RS08
	RS09
	RS09A
	RS09B
	RS91
	RS91B
	RS16
	RS17
	RS17A
	RS17B
	RS17C
	RS17D
	RS17E
	RS19
	RS19A
	RS20
	RS31-33
	RS3 5







Piston seals

Profile	Type
	PS01
	PS01A
	PS01B
	PS01C
	PS02
	PS02A
	PS03
	PS04
	PS05
	PS08
	PS08A
	PS08B
	PS08C
	PS08D
	PS08E
	PS08F
	PS81
	PS09
	PS09A
	PS16
	PS16A
	PS17
	PS17A
	PS17B
	PS19
	PS19A
	PS20
	PS23









Symmetrical seals

Profile	Type
	PRS06
	PRS06A
	PRS06B
	PRS06C
	PRS06D
	PRS06E
	PRS07
	PRS10SP
	PRS10-12
	PRS13-15
	PRS18
	PRS19
	PRS19B
	PRS19C
	PRS19D
	PRS22
	PRS25-27
	PRS99











Back-up rings

Profile	Type
	BUR08
	BUR09
	BUR10
	BUR 11
	BUR12
	BUR13



















Guide rings

Profile	Type
	BWR01
	BWR01A
	BWR03
	BWR04
	BWR05
	BWR06
	BWR07
	BWR08
	BWR09

Static seals and O-rings

Profile	Type
	FL01A
	FL02B
	FL03
	FL06
	FL07
	OR
	ORH
	ORV
	QR01
	QR02
	SS01

Rotary seals

Profile	Type
	OS01
	OS02
	OS03
	OS08
	OS08 A
	R03
	R04
	R04A
	R05
	R05A
	VR06
	VR07
	R08
	R08 D
	R09
	R09 A
	R10
	R10A
	R11



rod seals

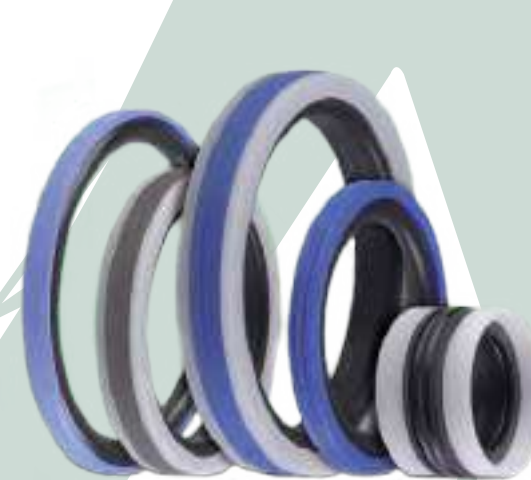

piston seals



wipers



static seals



guide rings

These profiles pictured are just some of our standard seal profiles. If you have a specific requirement, or require our specialised design input, please call us. We can help advise on the best profile and materials for your project.



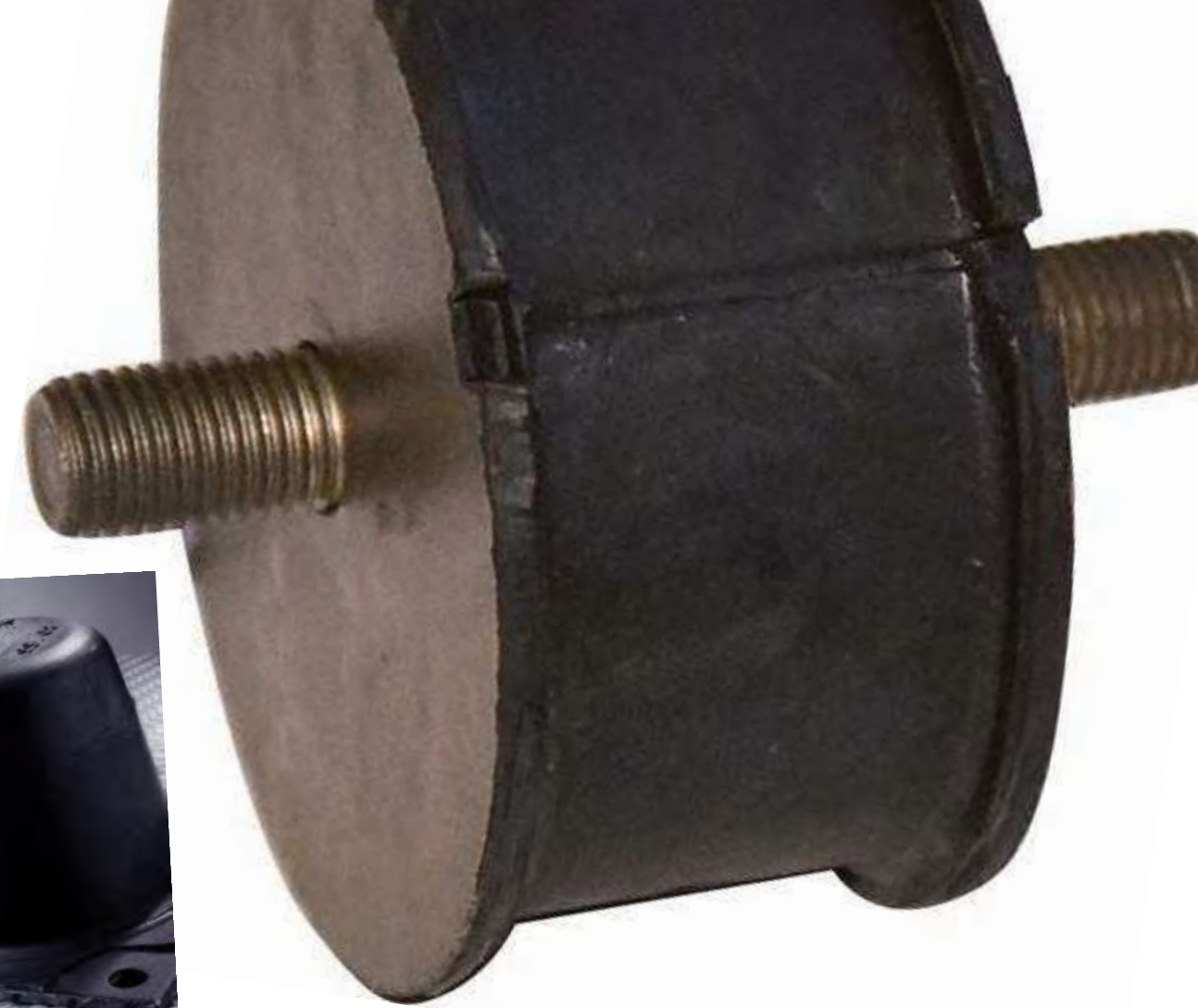
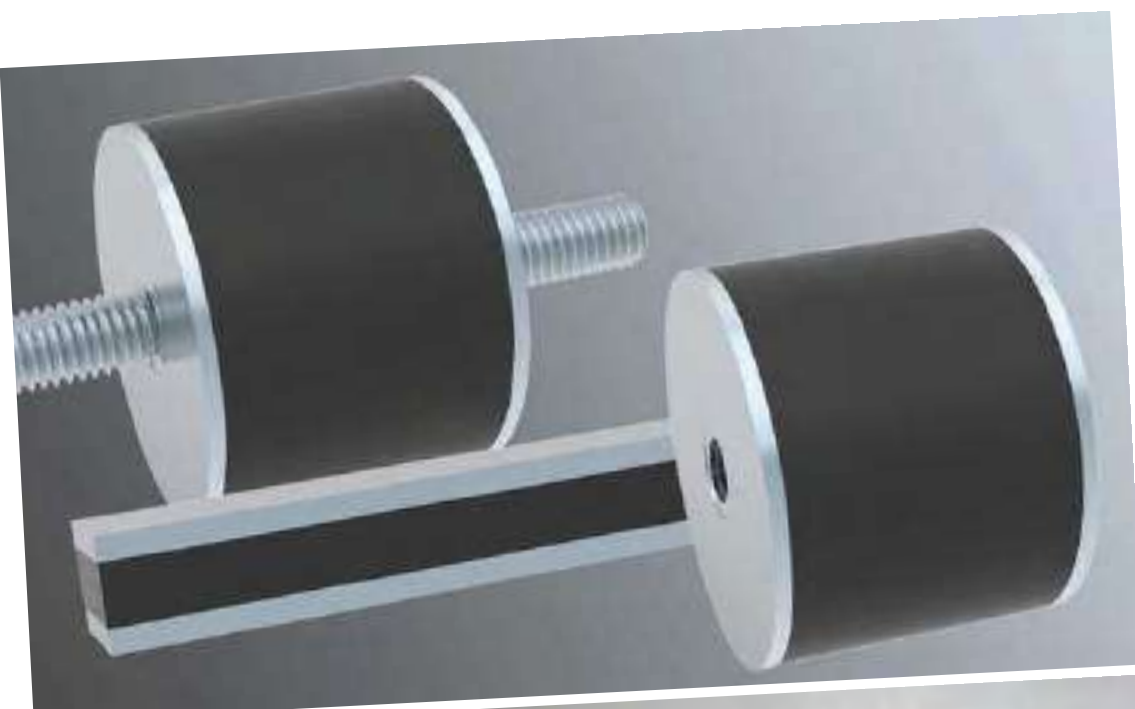

Buffers



Rubber buffers with external thread each side



Rubber buffers with internal and external thread



Rubber buffers with internal thread both side



Rubber buffers type DS suction foot



All rubber and P U product



Brushes

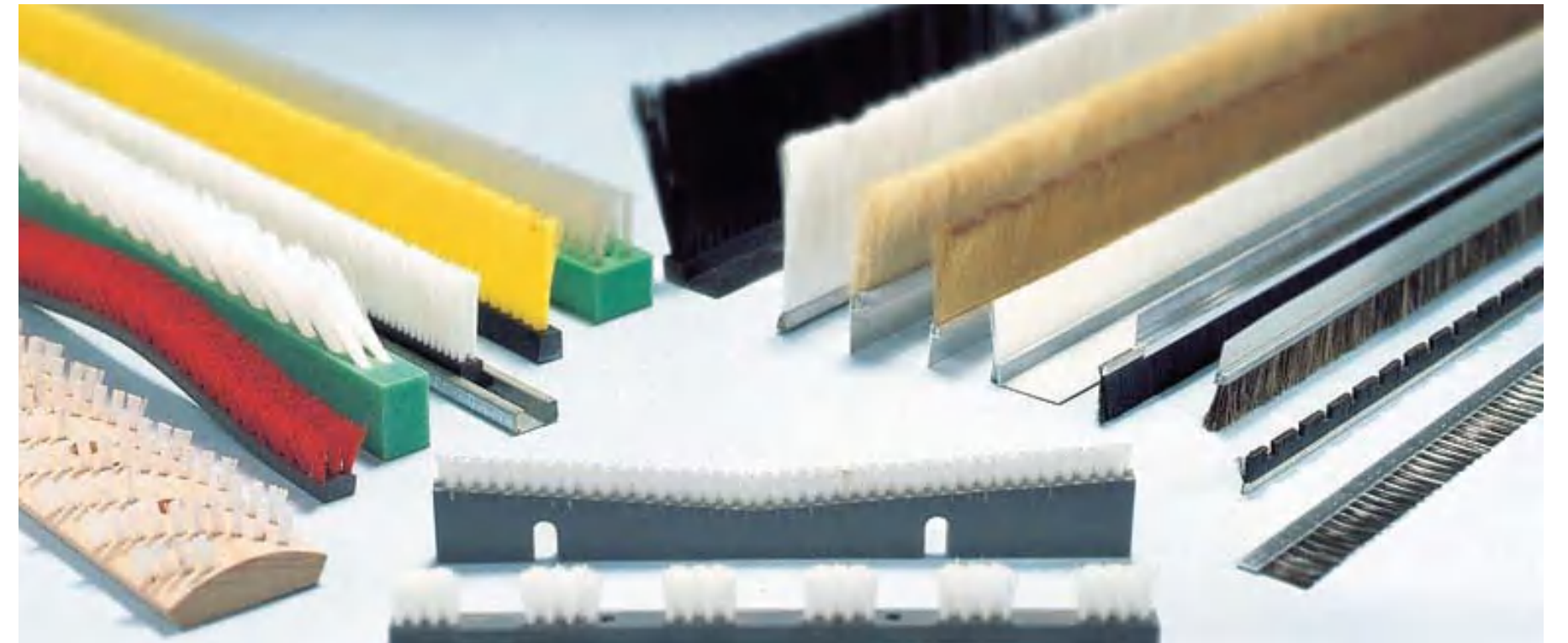

Hard strip Brushes



Nylon wheel brushes



Roller brushes



stright strips



coil brushes
cup type brushes
etc

Belts

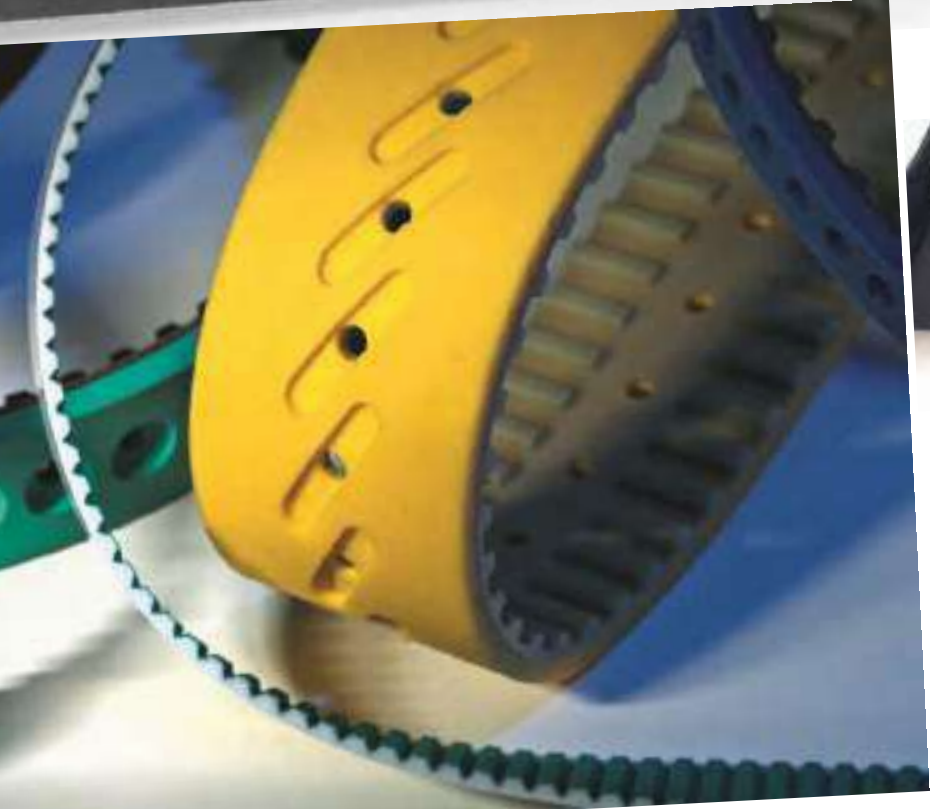
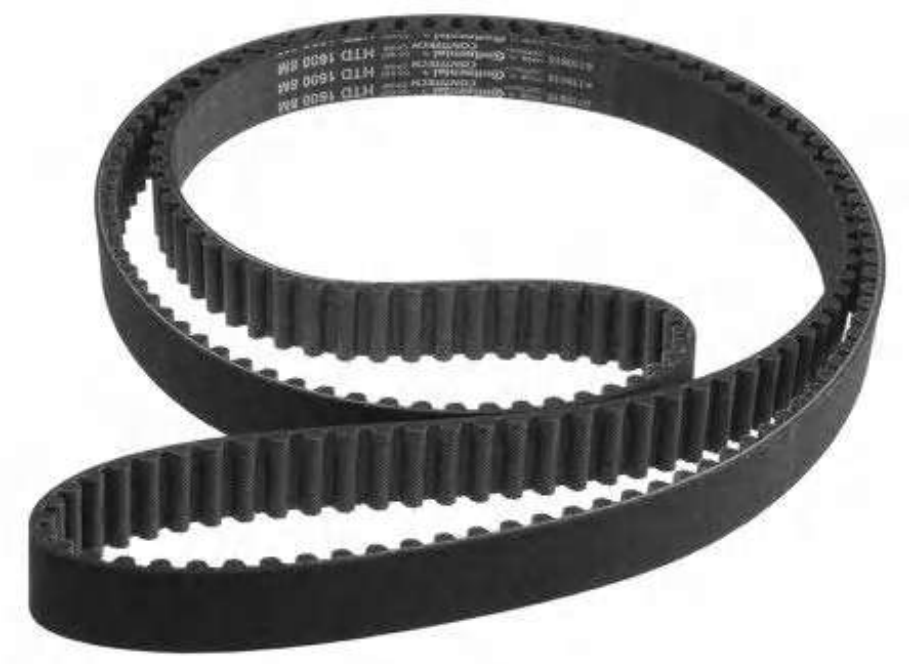
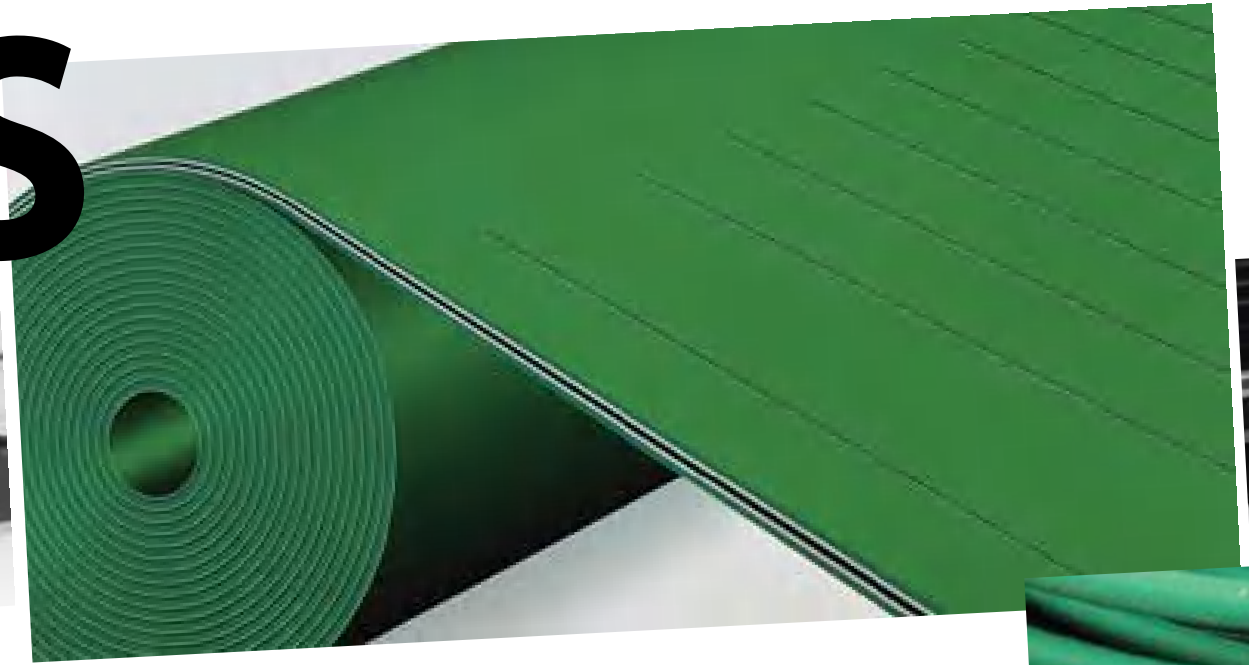

All types of v belts



Timing belts Polyurethane Belts



flat belt Conveyor Belts



Habasit flat belt



P U Round belt

bearing

A bearing is a machine element that constrains relative motion to only the desired motion, and reduces friction between moving parts



Drag Chain

Solution Provider



CABLE CHAINS CABLE CHAINS CABLE CHAINS CABLE CHAINS



SENSOR TECHNOLOGIES

FLOW SENSORS



PHOTO OPTIC SENSORS



RATE AND INERTIAL SENSORS



TORQUE SENSORS

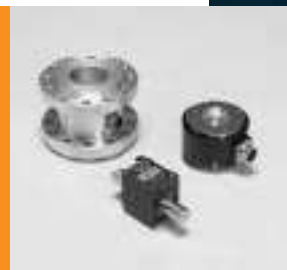

FORCE SENSORS



PIEZO FILM SENSORS



SCANNERS AND SYSTEMS



ULTRASONIC SENSORS
(air bubble, point level, continuous level monitoring)



HUMIDITY SENSORS



POSITION SENSORS



SPEED SENSORS



VIBRATION SENSORS

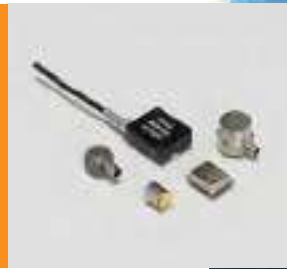

LIQUID LEVEL SENSORS



PRESSURE SENSORS



TEMPERATURE SENSORS



WATER LEVEL SENSORS



SENSOR SOLUTIONS





Proximity Sensor



Temperature Sensor



Pressure Sensor
pressure
measurement
of gases or liquids



Flow Sensor for
the measurement
of gas and
liquid flows



Other all sensors
cable and
acesories



Sensor/Actuator Cabling and Connectors

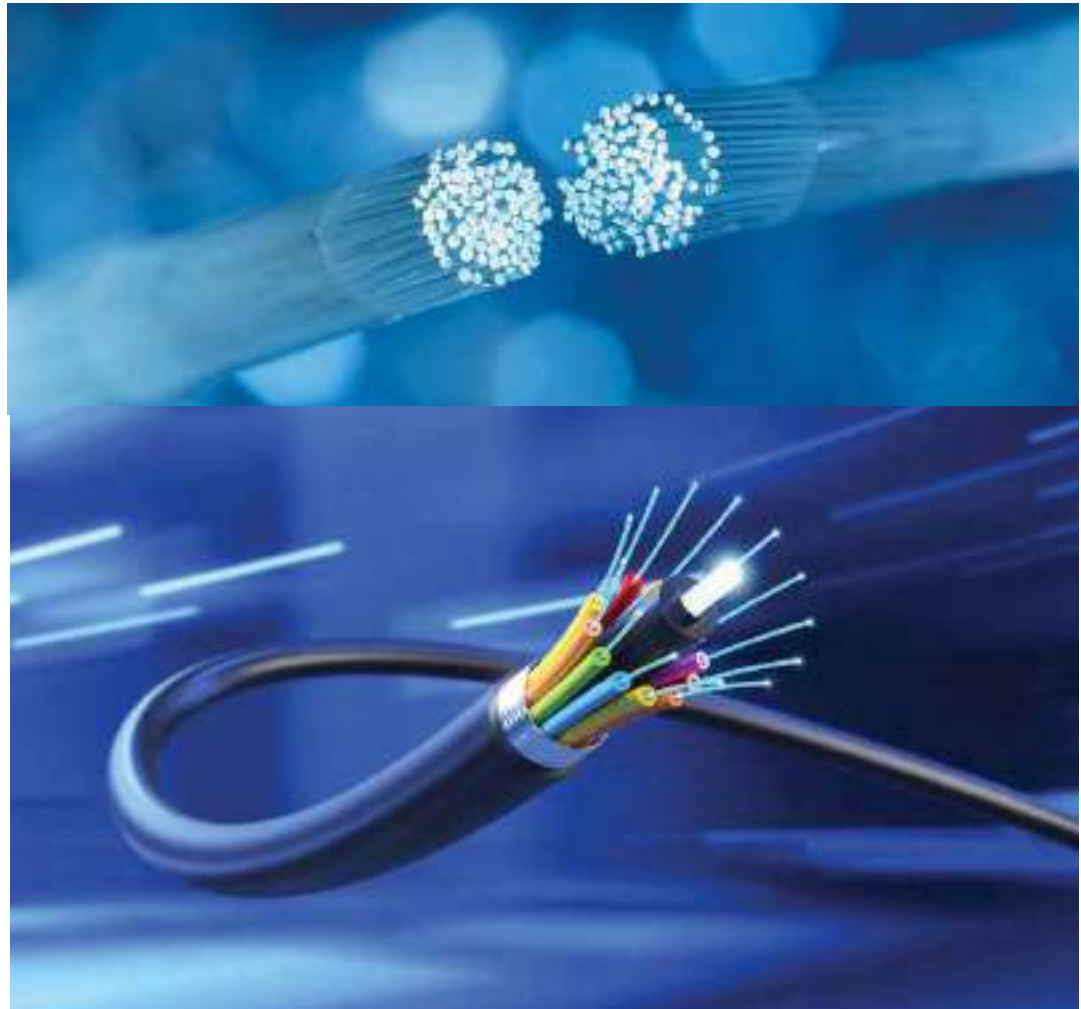

CORE PERFORMANCE FOR INDUSTRIAL PROCESSES

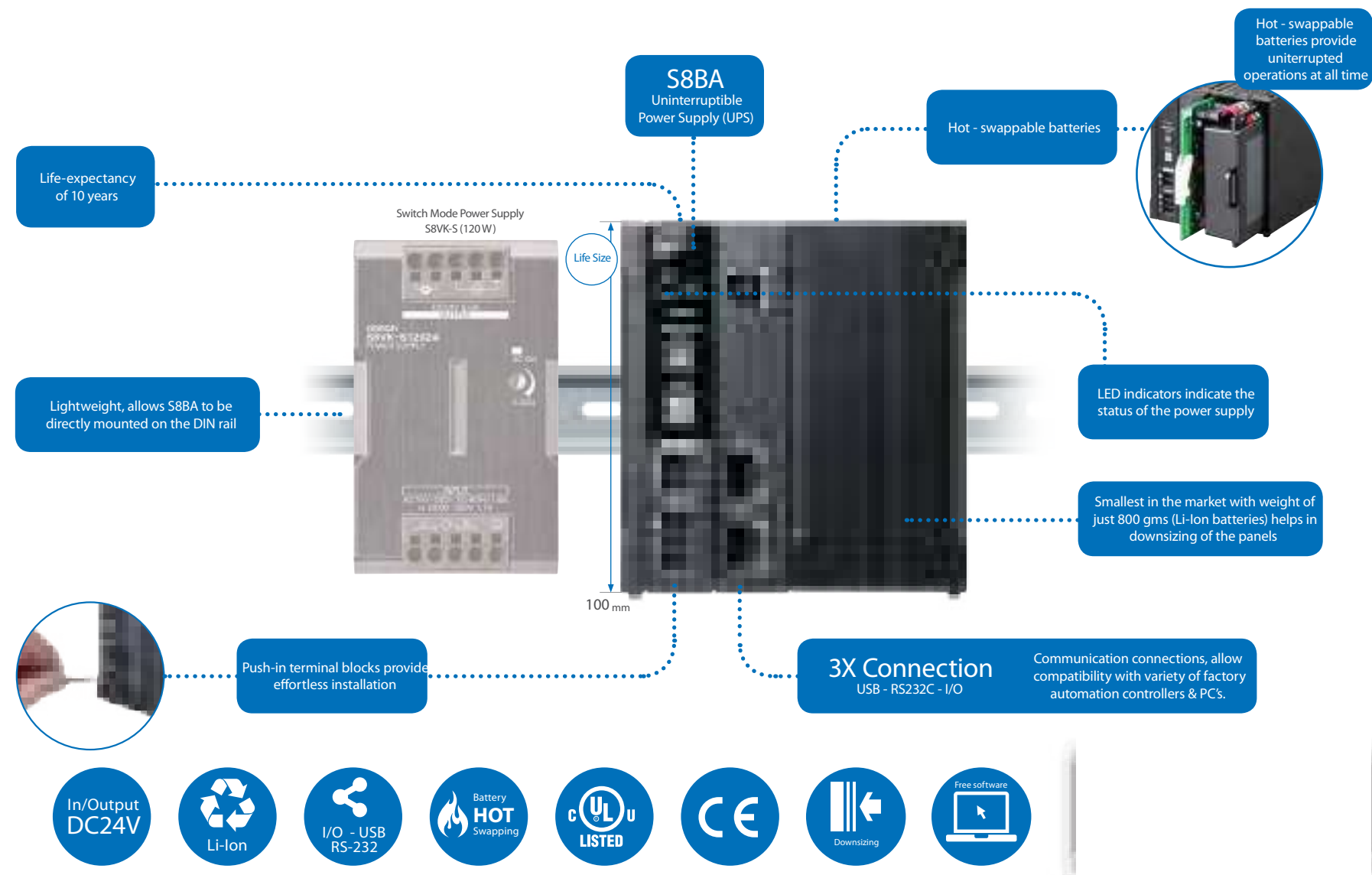

POWER SUPPLY SOLUTIONS

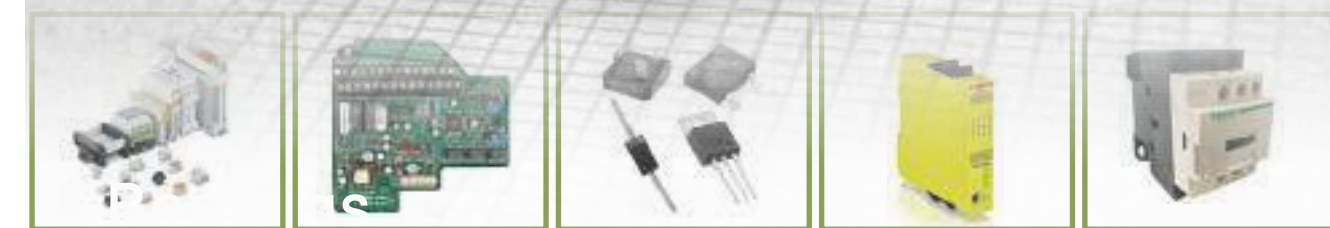
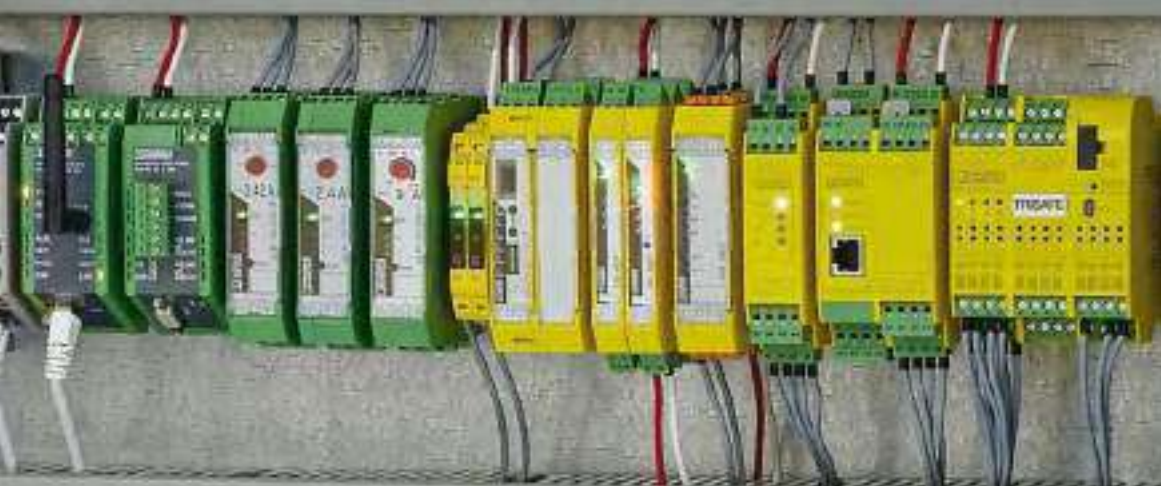

P L C Components Input and output module Rectifiers Safty relays and other relays All types of contactores

Power supplies and UPS

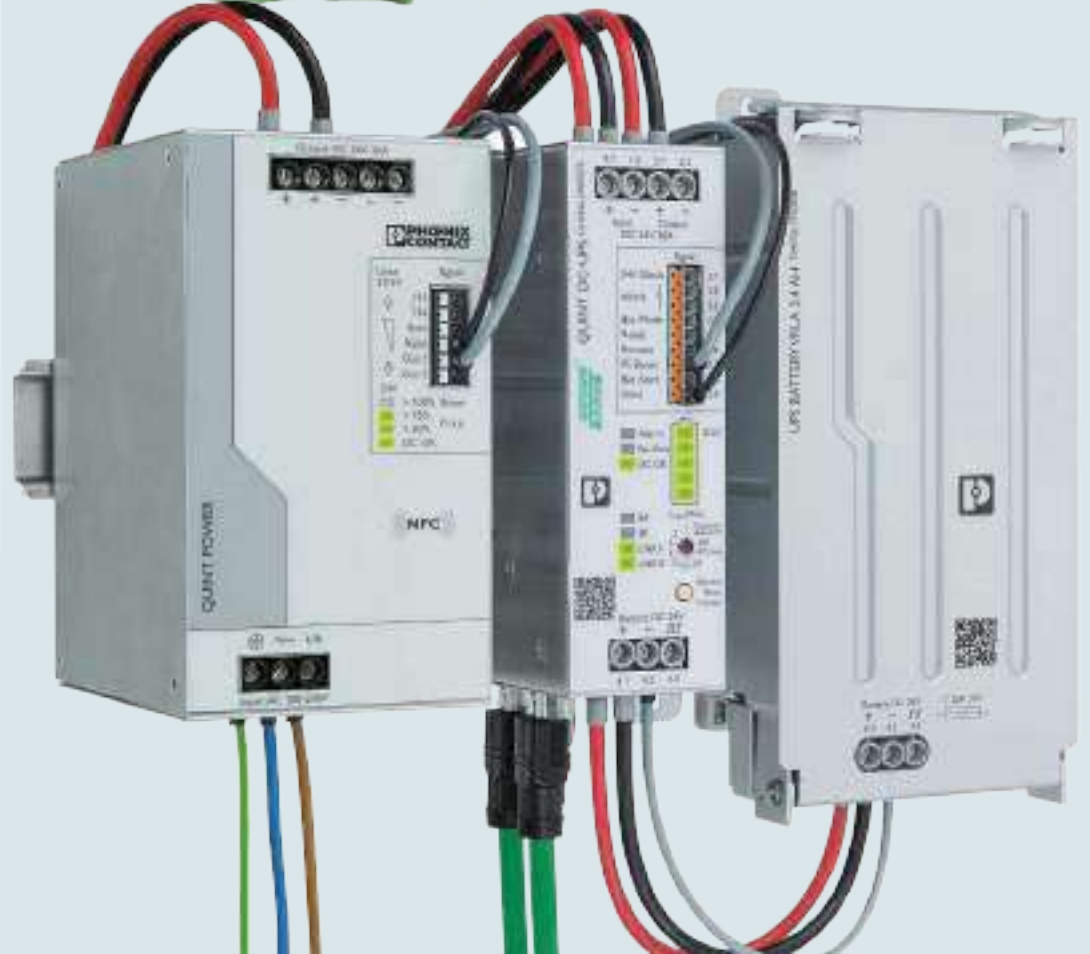

Others

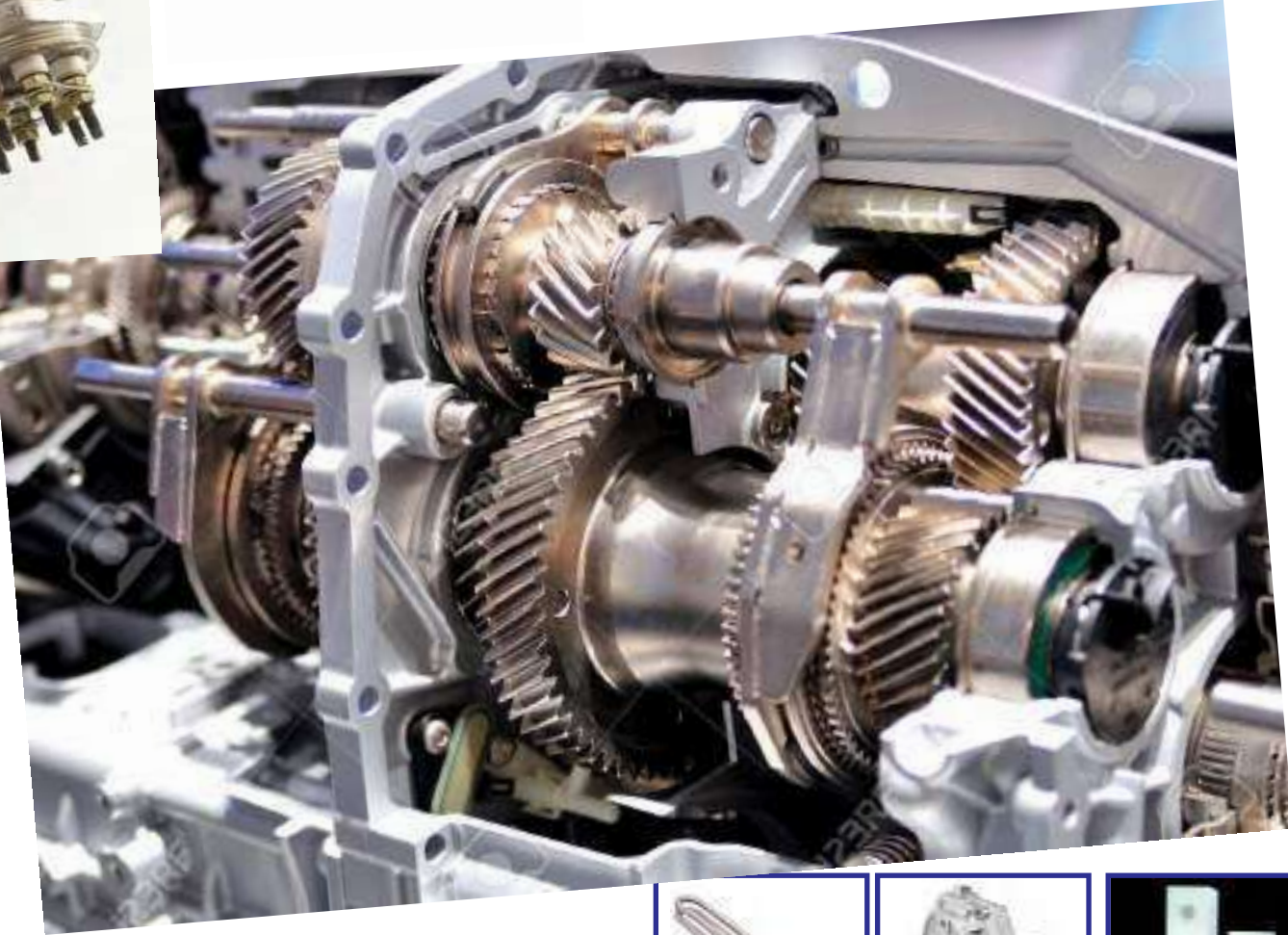

Electrical Industrial Heating Elements for Heaters

Gear box

Teflon blocks

Brushless Cooling Fan



ننسر للتجارة ذ.م.م
Tensor Trading W.L.L



LIFETIME TRUSTED PARTNERS
HYDRAULICS,PNEUMATIC,INSTRUMENTATION

COMMERCIAL REG. NO. 138332, TELEPHONE: +974 40094609, FAX NUMBER: +974 40054801 E-MAIL: sales@tensor.qa